



DAYWALK BeAssured 

- Safe and compliant logistics engineering
- Quality storage solutions
- Effective asset preservation

DESIGN > LOGISTICS
WWW.DAYWALK.COM

WHY DAYWALK

Daywalk is a specialist supplier in component transport solutions – design, certification and build. We offer innovative, fit-for-purpose transport and storage solutions to Australia's largest businesses. You can BeAssured in our innovative, world-class engineering.



Reliable and trusted for over 20 years



Superior engineering capabilities and standards



Innovative solutions to unique problems



Scalable for even the largest projects



Easy to deal with and responsive at every step



Extensive support and end-to-end training

LASH
POINT

Innovatively Built by
DAYWALK 
1300 662 987 > daywalk.com

THE DAYWALK

DIFFERENCE

Designed for **transport** - not just structural

Independently **certified** - you have complete assurance

End-to-end **guidance** - for assembly and load restraint

DAYWALK solutions can help you comply to:



Australian
standards



HNVL
Heavy Vehicle
National Law



Wind
loading



Materials
handling

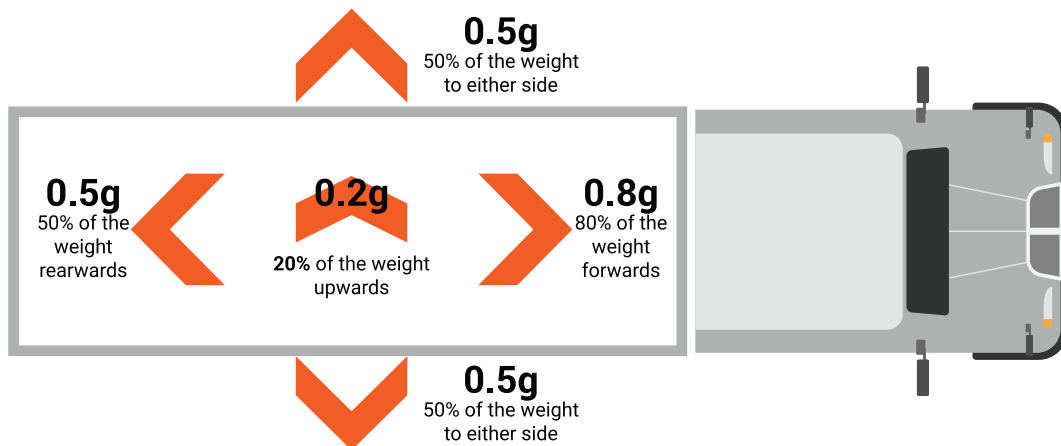

SAFE AND COMPLIANT TRANSPORT LOGISTICS

Get tailored precision systems that protect your assets and people.





Your challenges

Meeting legal obligations around the Chain of Responsibility.

Transporting multiple sizes of components or complex loads.

Looking to mitigate costs in the long run and not compromise on safety.

Our solutions

Precision engineered and independently certified to meet compliance laws.

Modular, versatile and multi-use designs that are mechanically engineered (not just structurally engineered).

Premium off-the-shelf options or total customisation available.

STEEL PALLET & ACCESSORIES

STEEL PALLET RANGE

Australian Patent 2020101895

Pre-certified in-stock custom frames straight off the shelf.

2T STORAGE

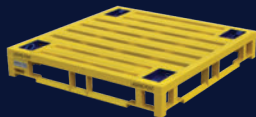

13-PSG1165

1T

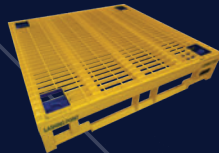

13-PSEG1160

2T

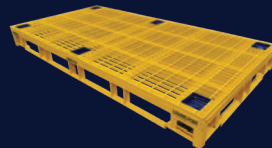

13-PSEG2320

1T



13-PSGG0580

2T

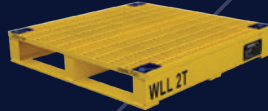

13-PSGG1160

3T

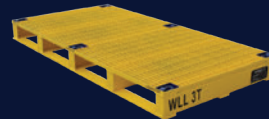

13-PSGG2320

6T

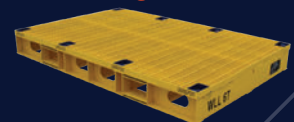

13-PSGG2320/1500/6T

3T



13-PMGG2320/1500

5T

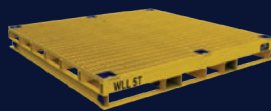

13-PMGG2320/2320

5.5T

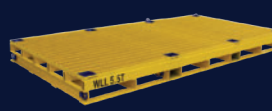

13-PMGG3500/1800

7T

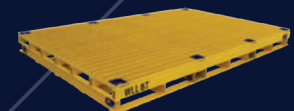

13-PMGG3500/2320

10T

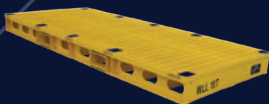

13-PSGG3500/1500

12T

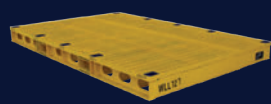

13-PSGG3500/2320

Ideal for transporting heavy equipment

Adjustable and compliant to Emergency Braking in Transport (EBiT)

Patented system that's safer than timber frames or pallets

Compatible with the DAYWALK Modular Bolting and chocking accessories



DAYWALK Value Proposition

STEEL PALLET ACCESSORIES

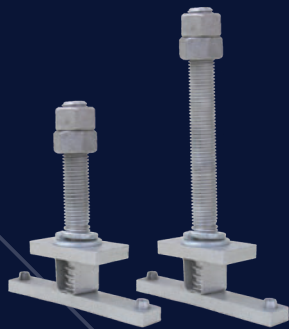

HOLD-DOWN BOLTS

- Safely and efficiently bolt items to Daywalk steel pallets
- Easy two-step push-and-twist installation
- Custom sizes and nyloc nut option available

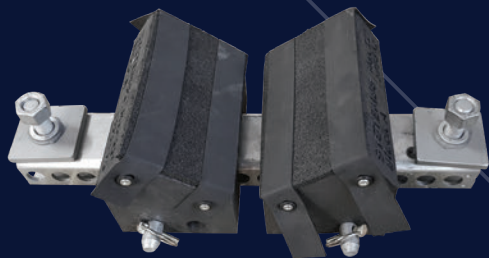

CHOCKING SYSTEMS

- Support cylindrical items during transport
- Load-resistant rubber lining minimises friction
- Adjustable rail for different component sizes

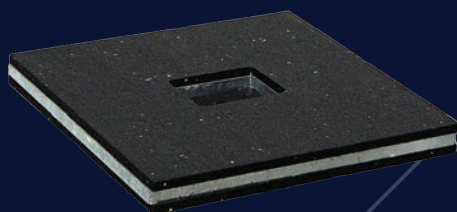

SPREADER PLATES

- Rubber inserts help distribute load weight safely
- Galvanised steel engineered for transport
- Prevents crushing during emergency braking



COMPONENT SPECIFIC SOLUTIONS

MODULAR CYLINDER SOLUTIONS

Australian Patent App 2021102166

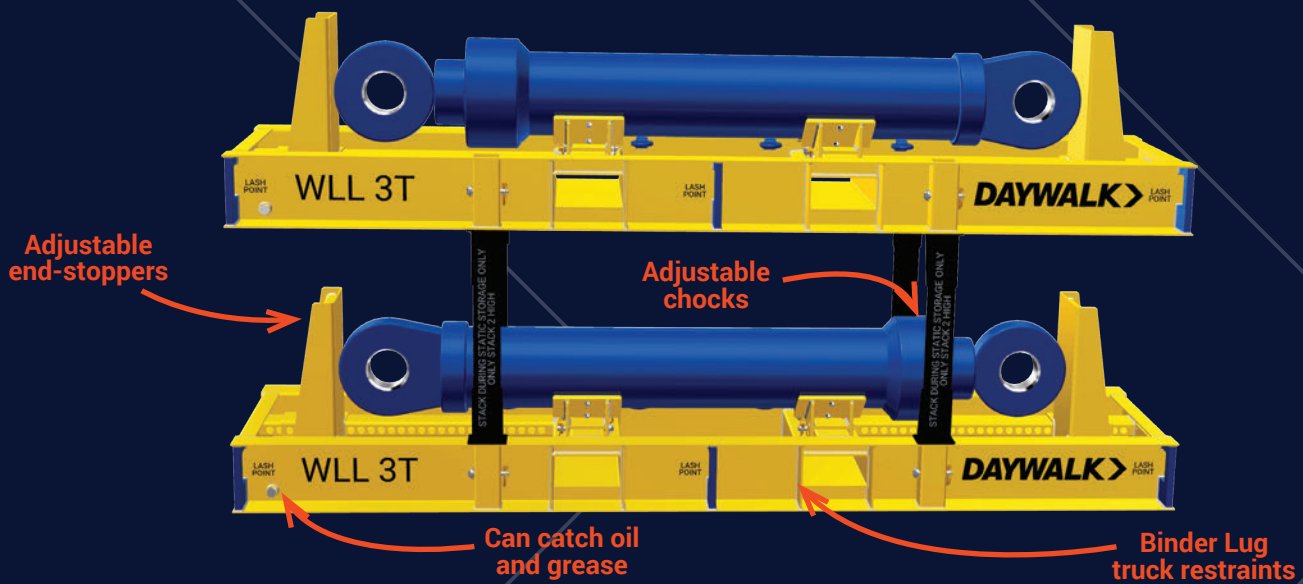

Unique and secure system for cylindrical components

Adaptable for different item diameters

End-stoppers for safety and drip tray for oil capture



ADJUSTABLE PUMP SOLUTIONS

Australian Patent 2021104657

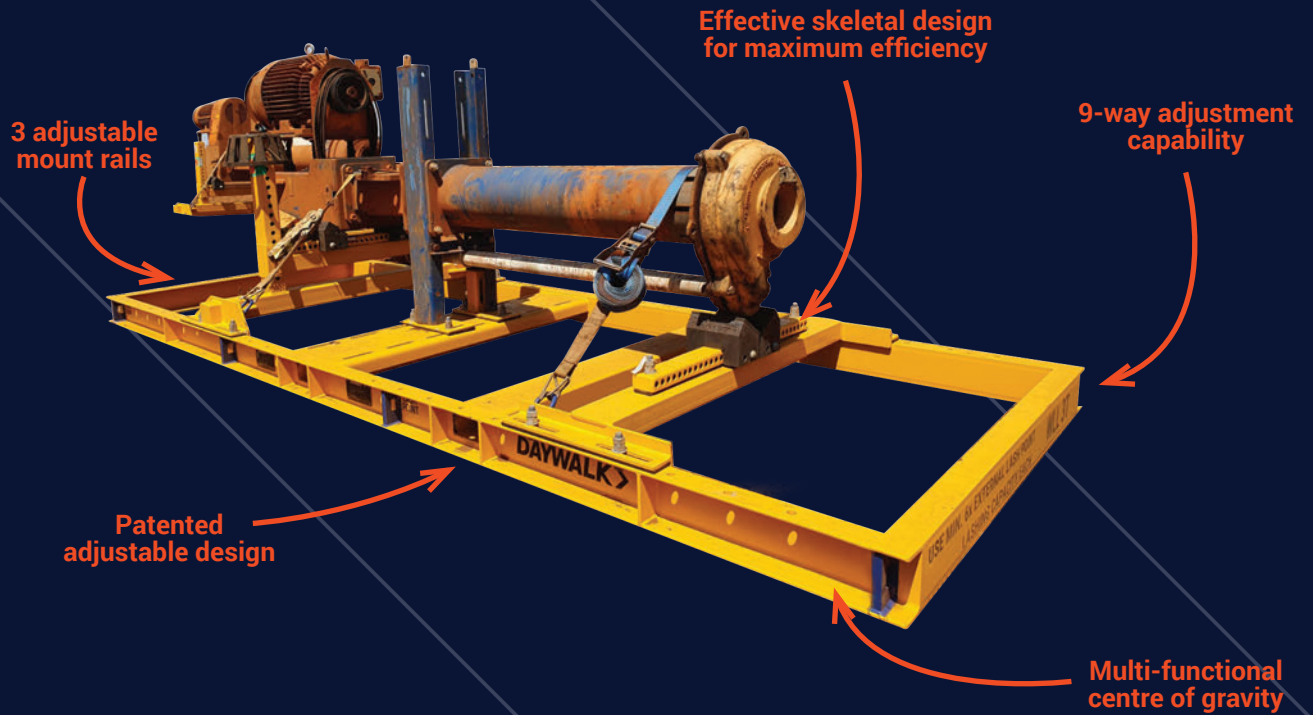

Patented logistics certified frame designed for functionality and safety

Nine-axis adjustability

Restraint lugs for safe pump restraint

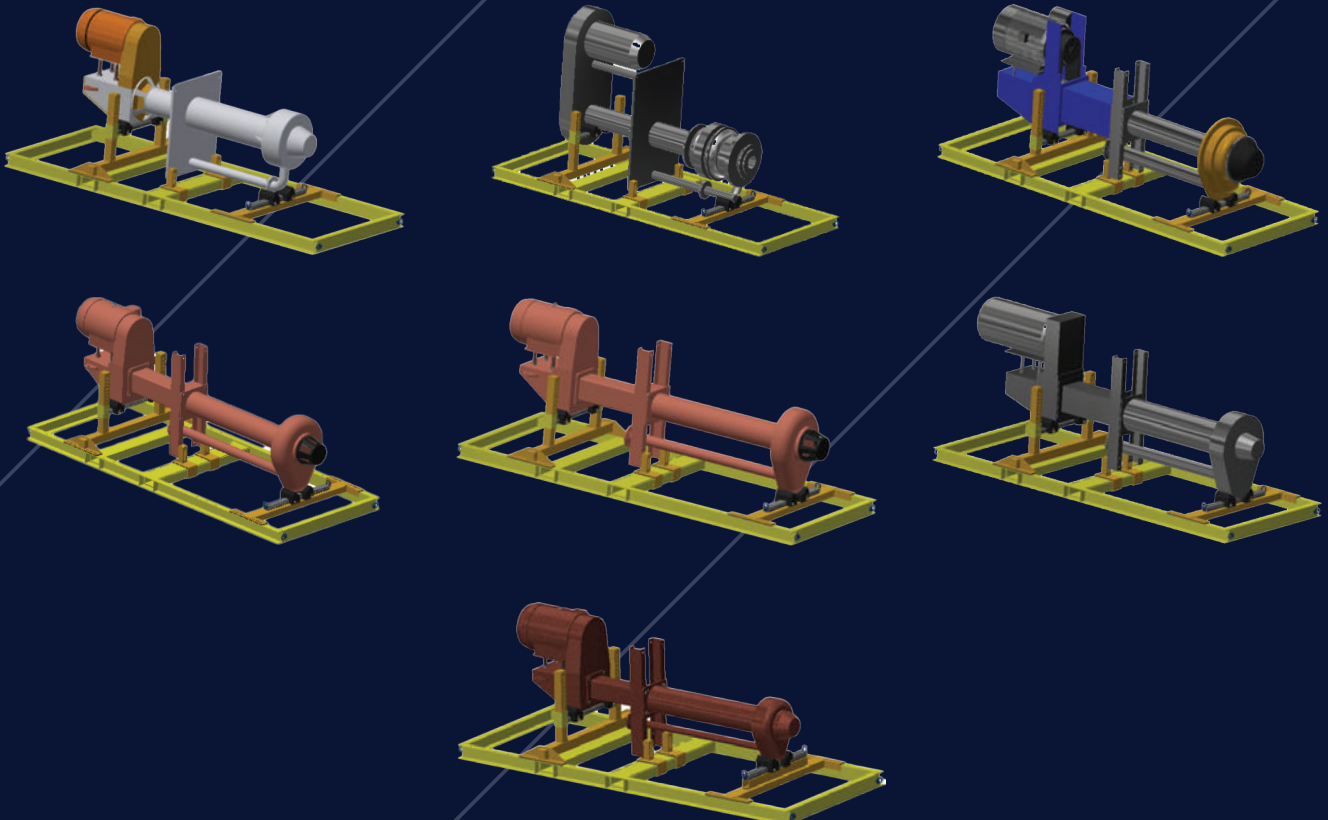

TRANSPORTA> SOLUTIONS

Australian Patent App 2022200310

Best-in-class weather cover

Emergency Braking in Transport (EBiT) compliant

Includes industry leading QR Code with loading and lashing guidance



Best-in-class integrated transport frame for transformers

Complete protection and logistics certified

Includes options for bunding for transformers

Multiple sizes available up to 16T



FULLY CUSTOMISED SOLUTIONS

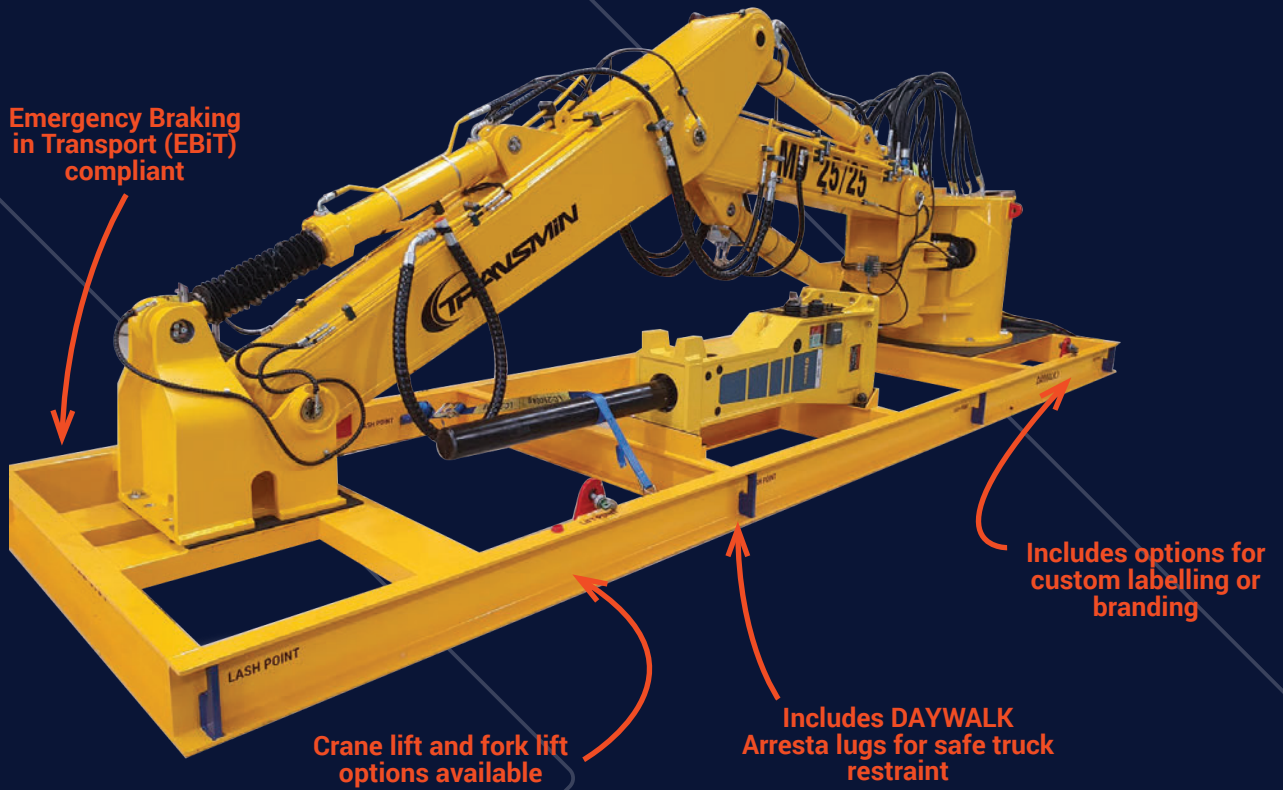

Specialists in bespoke solutions to match your requirements

World-class engineering capabilities

Full design, certify and build process



DAYWALK

END-TO-END SUPPORT



DETAILED AFTER CARE AND MANAGEMENT

Easy to use QR codes for paperless instructions of product care and use

Product specific guides for ease of use

24/7 call support

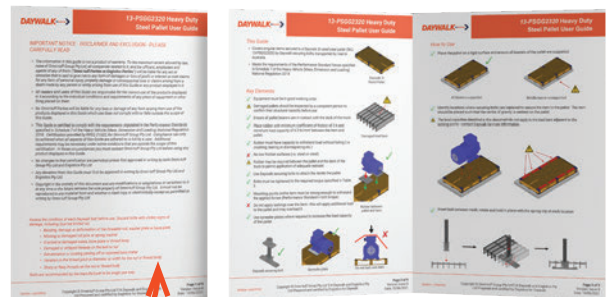
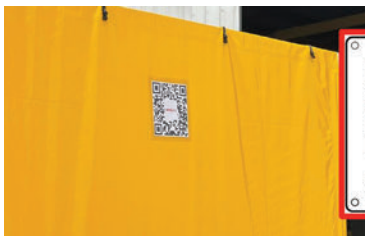

OUR PROCESS

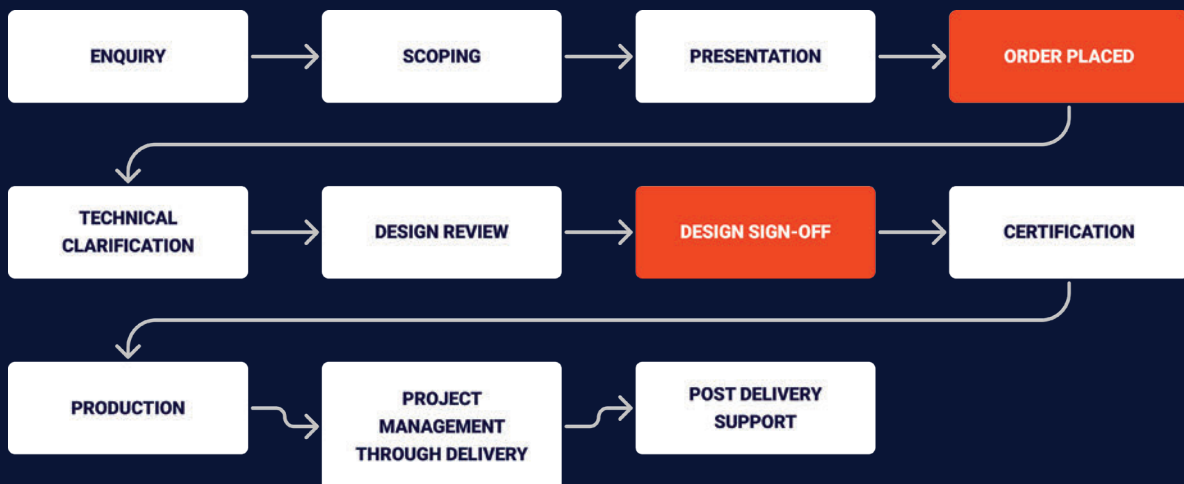

QUALITY STORAGE SOLUTIONS

Durable cages, stillages and pallets made for the toughest environments.



Your challenges

Minimising inefficiency and maximising usable warehousing space.

Reducing unsafe and difficult-to-manage storage practices.

Looking for economical and readily available alternatives.

Our solutions

Flexible, stackable options that are racking compatible and collapsible.

Rated and approved range that free valuable space with storage verticality.

In-stock and ready-to-go storage vessels and strapping devices.

OPTIONS AVAILABLE

STEEL CAGES AND STILLAGES

Tough and ideal for heavier components and storing multiple SKUs

Designed for Australian pallet racking – with easy access

Galvanised, stackable and collapsible options available



13- PSS500C/INT/HD



13- PSS800C/INT/HD



13- PSS800/2200/C/INT



13- PSS1100SSDP



13-PMC300RD2PH
13-PMC500RD2PH
13-PMC800RD2PH



TIMBER PALLETS AND COLLARS

Flexible and affordable way to store items
 Double pallets ideal for longer, larger gear
 Stencilling available for site identification



13-PH1165



13-PCS1165



LIDS, DIVIDERS AND
 OTHER ACCESSORIES
 AVAILABLE

PLASTIC PALLETS AND BINS

Ideal for exporting – no heat-treating required
 Suitable for forklifts and pallet jacks, with UV-stabilisation for long-term storage
 Collapsible and stackable options available



13-CSB1165/SVUR/R

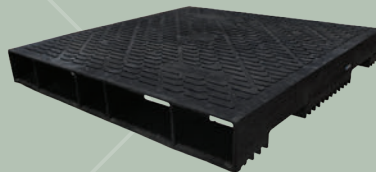

13-NS900

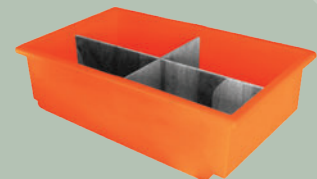

16-CP3422100
 (dividers extra)

STRAPPING AND RESTRAINTS

Tool servicing available
 - Free loan tools if you also buy strap
 - Large parts stock holding
 - Fixed price labour schedule

Recyclable PET for fast-paced, and high-volume operations
 Polywoven for round or oddly-shaped items
 Reusable camlock straps to save time and money in storage



03-ITA21/19KIT
 PET Strapping Starter Kit



03-CHD/NKIT
 Polywoven Strapping Starter Kit



19-CBS50/5/500



19-CBS50/7/500



06-SPET19100PEPK



06-SPET191000EPK



EFFECTIVE ASSET PRESERVATION

Stop needless waste of your most valuable assets.

Your challenges

Preventing moisture that leads to corrosion of your critical components.

Protecting your equipment from adverse weather, dust and contaminants.

Reducing cost and waste associated with plastic wrapping.

Our solutions

Volatile corrosion inhibitor (VCI) technology for superior rust protection.

Flexible and UV-stabilised covers and bags for all sizes of equipment.

Reusable outer wraps that are cost effective and more sustainable.

OUR **THREE-STEP** PRESERVATION MODEL

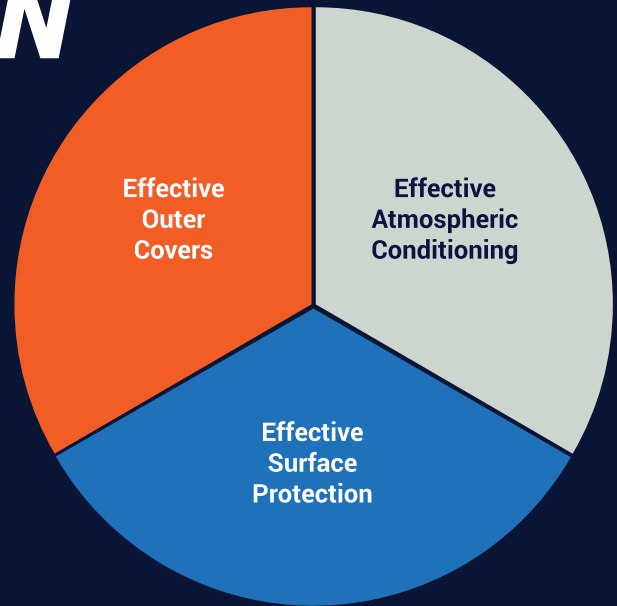

WHAT IS **VCI?**

Scientifically Proven –VCI is effective because it gets dissolved in the moisture and forms a mono-ionic layer on the metal surface.

Self-replenishing & re-healing -The protective barrier re-heals and replenishes itself through further condensation of the vapour.

A system that works -DAYWALK specially designed, high performing Master batch gives full proof protection through our integrated approach. Zero corrosion claims to date.

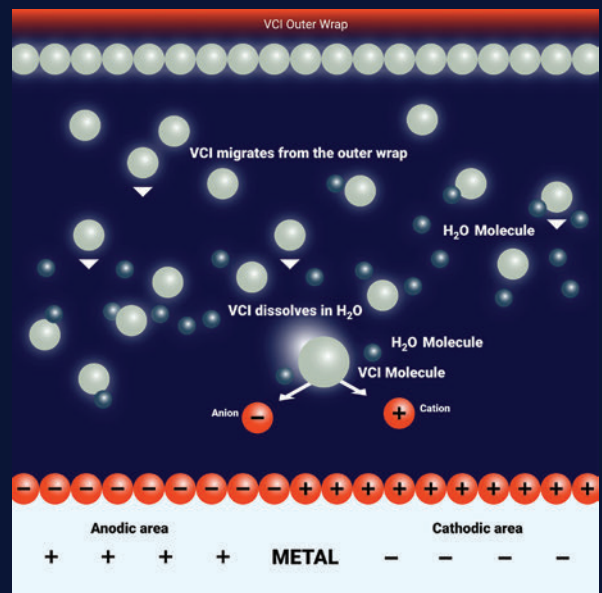

WHAT DOES IT LOOK LIKE?



BARE METAL

ZIP SEAL BAG

UV PLASTIC

UV/VCI PLASTIC

UV/VCI STRETCH FILM

COVERS AND CONDITIONING

COVERS

- Ideal for sealing against weather and dust
- UV-stabilised to ensure long-lasting protection
- Reusable covers available to reduce waste and costs
- Includes VCI for effective rust prevention



12-LFSWUBC5425/30



03-RP3000/THS/KIT

CONDITIONING

- Effective atmospheric control
- Neutralises moisture and forms a protective layer
- Scientifically proven – with zero corrosion claims to date



09-SP-MDE



09-VCI Powder



09-VCI Desiccant



SURFACE PROTECTION

PROTECTING

Superior surface metal protection

Flexible and affordable over the life of your asset

Unique peelable coatings available



04-SKN45/4



04-SKN45/AER380



04-SKN20/4



DAYWALK ©

DISCLAIMER: While all effort has been made to represent the products accurately, details may vary due to photography and videography processes. The customer will make their own assessment as to the suitability of the products for the customer's purposes. The actual use of the product is within the sole control of the customer and Omni-tuff Group Pty Ltd t/a DAYWALK will not be responsible for such loss or damage resulting from such use. Sales are subject to standard terms and conditions of trade of Omni-tuff Group Pty Ltd t/a DAYWALK. E&OE Please note, final solutions delivered by DAYWALK may vary as per customer requirements or engineering approval.

DESIGN  LOGISTICS

1300 662 987

WWW.DAYWALK.COM